

1/S1
v 3.3 (en)

VENTILATION GRILLES

OAH, OAV, OAB, OAK, OAN, OAS, OAM,
OCM, PCR, ORP, PTR, CCH, CCV, CRH,
CRV, NRA, NRK



TABLE OF CONTENTS

Aluminium grilles.....9
 Special grilles.....12
 Fancoilgrilles.....13
 Steelgrilles.....14
 Lineargrilles.....15
 Dampers.....18
 Ordering key.....19
 Installation instructions.....20
 Plenum boxes.....23
 Effective discharge areas.....26
 Selection diagrams.....29

Definition of symbols

V (m ³ /h)	- Air flow
v_{ef} (m/s)	- Effective air velocity
v_L (m/s)	- Maximum air velocity on a distance L
$B \times H$ (mm)	- Standard grille dimensions
A_{ef} (m ²)	- Effective discharge area
h (m)	- Vertical distance from grille to ceiling
D (m)	- Horizontal distance between two grilles
L (m)	- Air throw
i	- Air induction
t_z (°C)	- Supply air temperature
t_r (°C)	- Room air temperature
t_p (°C)	- Core temperature on a distance L
Δt_z (°C)	- ($t_z - t_r$)
Δt_L (°C)	- ($t_r - t_p$)
$b_{0,2}$ (m)	- Jet width - distance between jet core and point where velocity equals 0,2 m/s
yt (m)	- Air jet deflection
α (°)	- Jet dissipation angle
β (°)	- Blade angle
L_{WA} (dB(A))	- Sound power level
Δp (Pa)	- Pressure drop

Discharge scheme

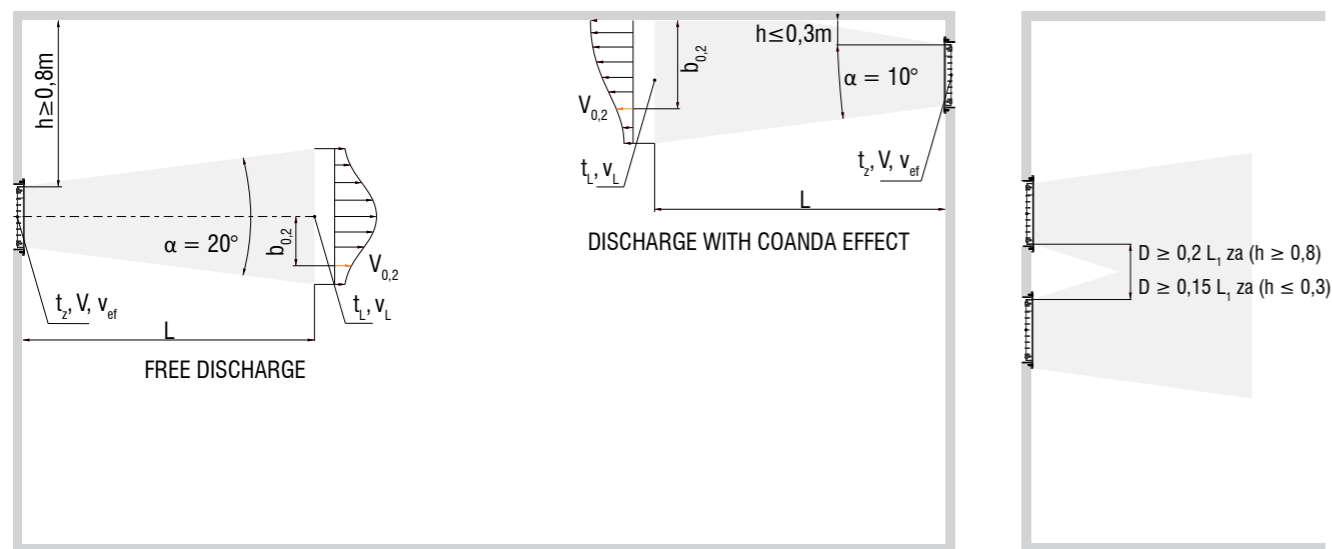

ALUMINIUM GRILLES

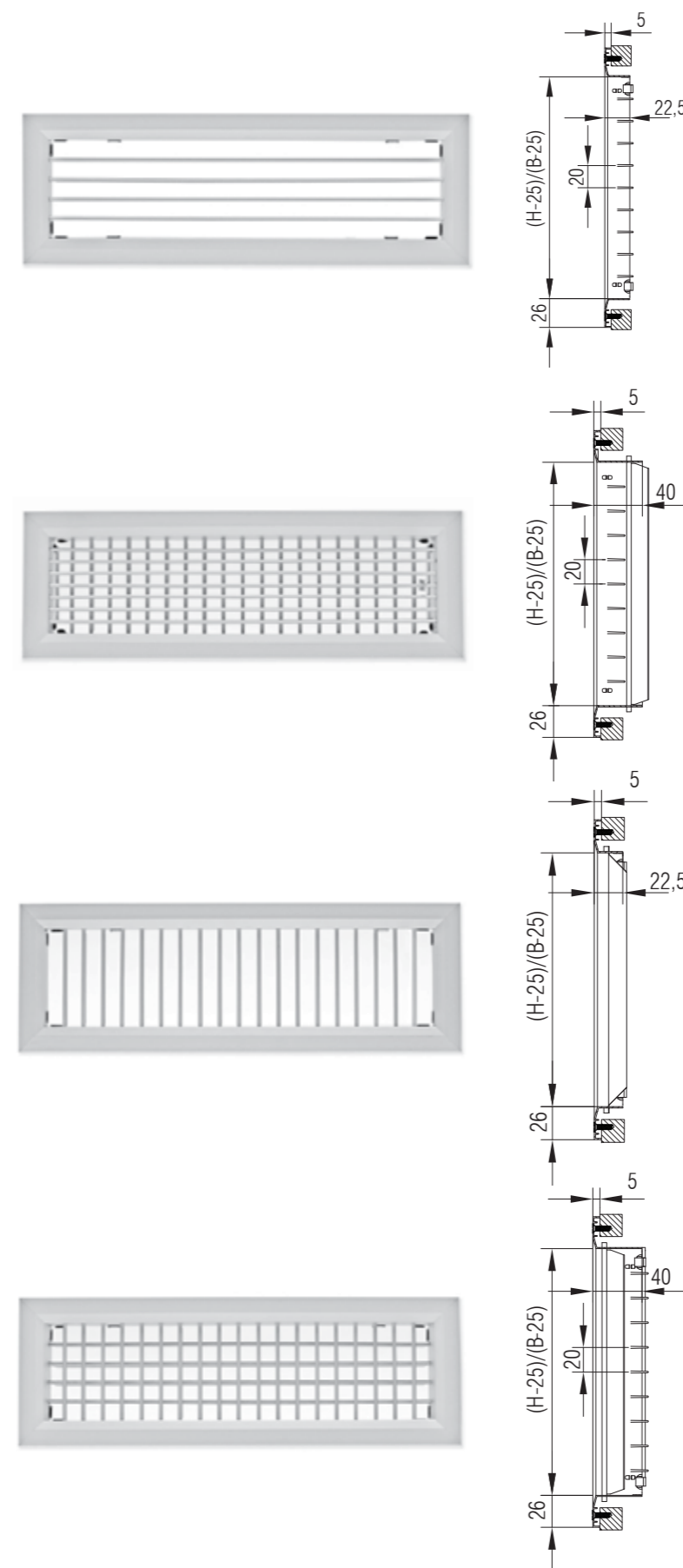

OAH 1

- frame and blades made out of anodized aluminium profiles
- one row of horizontal individually adjustable blades
- fixing with visible screws (wall and ceiling)
- fixing with mounting frame (UR) only in wall

OAH 2

- frame and blades made out of anodized aluminium profiles
- front row of horizontal individually adjustable blades
- back row of vertical individually adjustable blades
- fixing with visible screws (wall and ceiling)
- fixing with mounting frame (UR) only in wall

OAV 1

- frame and blades made out of anodized aluminium profiles
- one row of vertical individually adjustable blades
- fixing with visible screws (wall and ceiling)
- fixing with mounting frame (UR) only in wall

OAV 2

- frame and blades made out of anodized aluminium profiles
- front row of vertical individually adjustable blades
- back row of horizontal individually adjustable blades
- fixing with visible screws (wall and ceiling)
- fixing with mounting frame (UR) only in wall

*Options pg. 20
 **Installation pg. 21
 ***Standard dimensions pg. 13

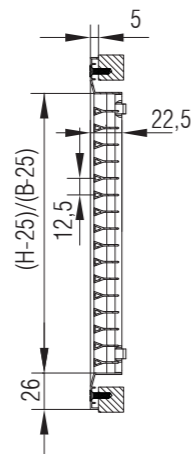

OAB 1-0

- frame and blades made out of anodized aluminium profiles
- one row of horizontal fixed blades
- fixing with visible screws (wall and ceiling)
- fixing with mounting frame (UR) only in wall

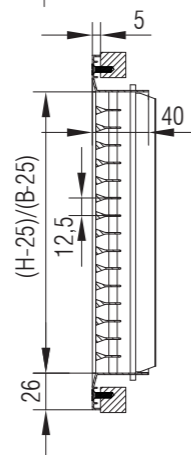
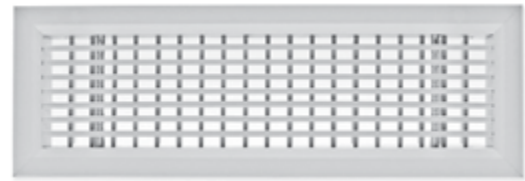

OAB 2-0

- frame and blades made out of anodized aluminium profiles
- front row of horizontal adjustable blades
- back row of vertical adjustable blades
- fixing with visible screws (wall and ceiling)
- fixing with mounting frame (UR) only in wall

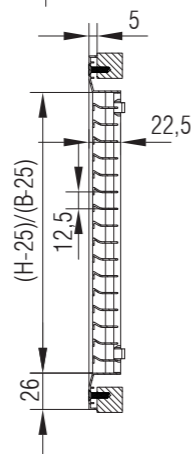

OAB 1-15

- frame and blades made out of anodized aluminium profiles
- one row of horizontal fixed blades with deflection angle 15°
- fixing with visible screws (wall and ceiling)
- fixing with mounting frame (UR) only in wall

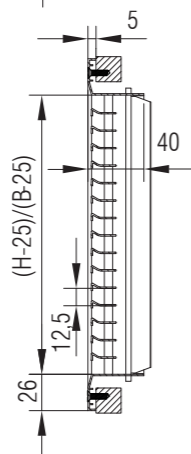

OAB 2-15

- frame and blades made out of anodized aluminium profiles
- front row of horizontal fixed blades
- back row of vertical adjustable blades
- fixing with visible screws (wall and ceiling)
- fixing with mounting frame (UR) only in wall

*Options pg. 20
 **Installation pg. 21
 ***Standard dimensions pg. 13

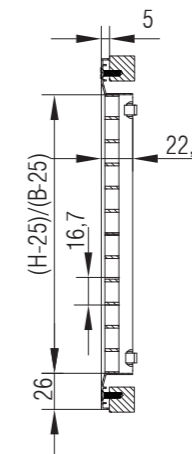
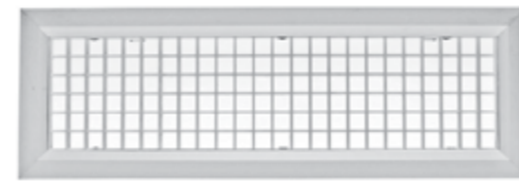

OAK

- frame made out of anodized aluminium profiles
- fixed plastic rectangular mesh
- fixing with visible screws (wall and ceiling)
- fixing with mounting frame (UR) only in wall

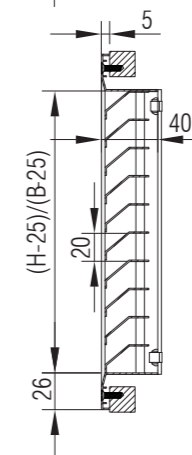

OAN

- frame and blades made out of anodized aluminium profiles
- one row of horizontal fixed blades
- fixing with visible screws (wall and ceiling)
- fixing with mounting frame (UR) only in wall

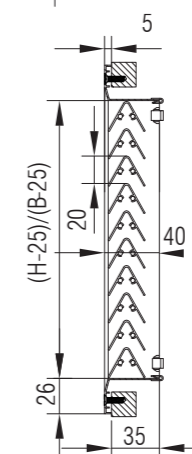
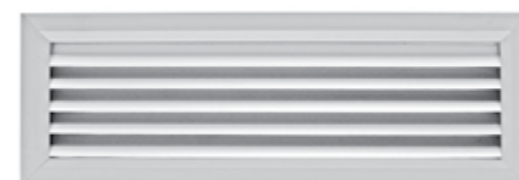

OAS

- frame and blades made out of anodized aluminium profiles
- one row of horizontal fixed blades
- fixing with visible screws (wall and ceiling)
- fixing with mounting frame (UR) only in wall

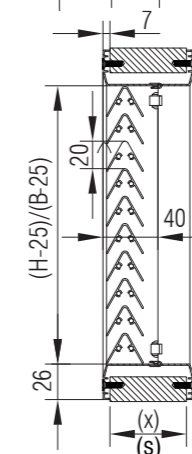

OAS - R

- frame, counterframe and blades made out of anodized aluminium profiles
- one row of horizontal fixed blades
- counterframe for back side of the door
- fixing with visible screws (wall and ceiling)
- known door width (s=35 - 50 mm)

*Options pg. 20
 **Installation pg. 21
 ***Standard dimensions pg. 13

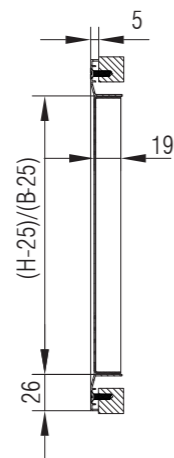

SPECIAL GRILLE

OAM

- frame made out of anodized aluminium profiles
- fixed mesh made out of aluminium sheet
- fixing with visible screws (wall and ceiling)
- fixing with mounting frame (UR) only in wall

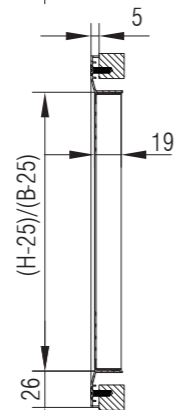

OCM

- frame made out of anodized aluminium profiles
- fixed mesh of perforated steel sheet
- perforation 6x6mm, step 8,5mm
- powder coated in white RAL 9010
- fixing with visible screws (wall and ceiling)
- fixing with mounting frame (UR) only in wall

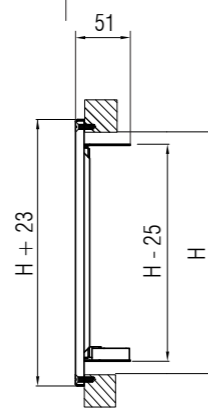

PCR

- frame made out of steel sheet profiles
- fixed mesh of perforated steel sheet
- round perforation 4mm, 40%
- powder coated in white RAL 9010
- fixing with visible screws
- perforated cover opens around axis on B side
- closing mechanism on back side of the cover

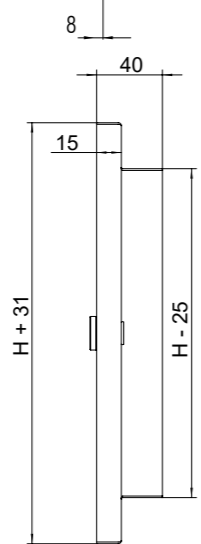

OCP

- frame made out of stainless steel
- fixed mesh of perforated steel sheet
- round perforation
- fixing with screws (only in wall)

*Options pg. 20
**Installation pg. 21

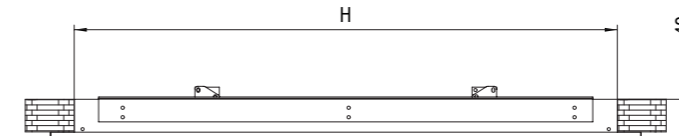
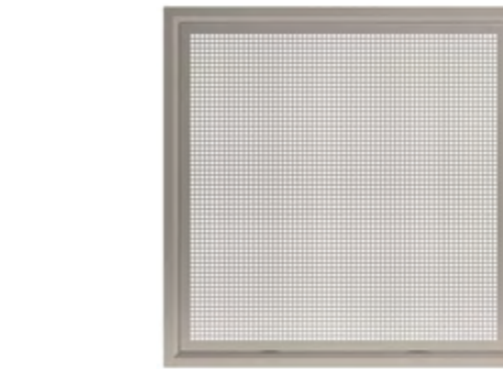

FAN-COIL GRILLE

ORP

- frame and screen made out of anodized aluminium profiles
- installation in suspended ceiling
- free hanging perforated screen with click lock
- fixed with angle and M6 screws
- standard dimensions: 500 x 500
600 x 600
700 x 700



Adjustable supply grille PTR

- frame and blades made out of anodized aluminium profiles
- front row of horizontal adjustable, interconnected blades (deflection angle ± 30°)
- fixing with visible screws (wall and ceiling)
- fixing with mounting frame (UR) only in wall
- standard dimensions pg. 12

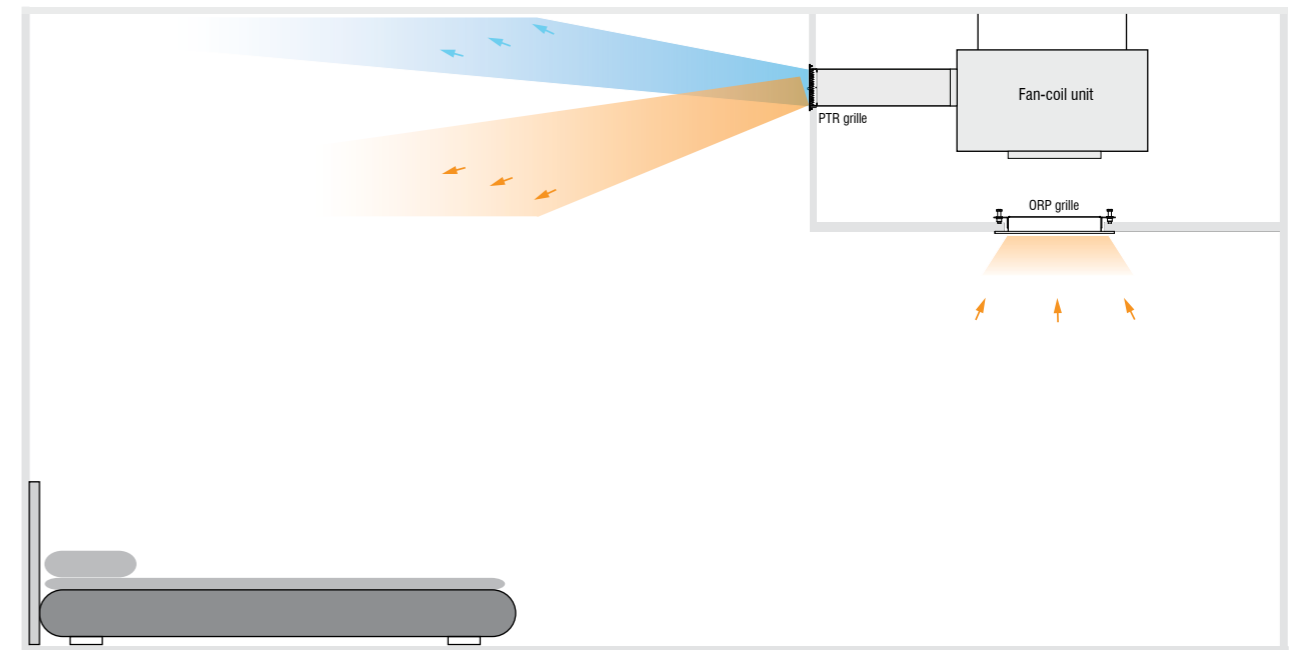

Standard dimensions for aluminium grilles

B	225 - 1225 mm, in increments 100mm
H	125 - 525 mm, in increments 100mm

* B > H

*Options pg. 20
**Installation pg. 21

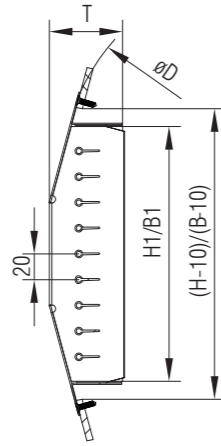

STEEL GRILLES FOR ROUND DUCT

CCH 1

- one row of horizontal individually adjustable blades
- frame and blades made out of galvanized steel
- fixing with screws
- installation on round duct

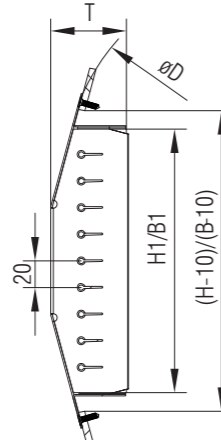

CCH 2

- front row of horizontal individually adjustable blades
- back row of vertical individually adjustable blades
- frame and blades made out of galvanized steel
- fixing with screws
- installation on round duct

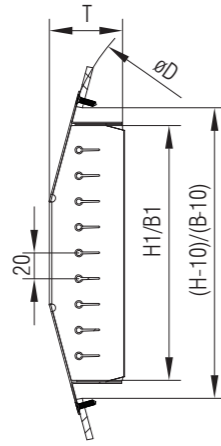

CCV 1

- one row of vertical individually adjustable blades
- frame and blades made out of galvanized steel
- fixing with screws
- installation on round duct

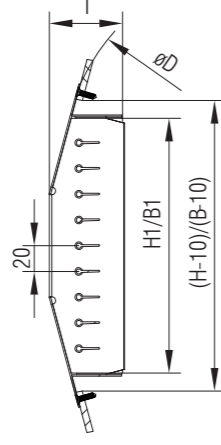
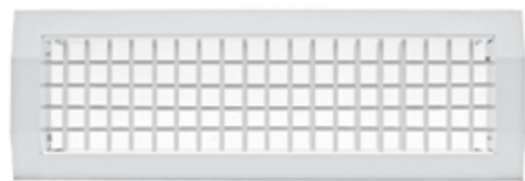

CCV 2

- front row of vertical individually adjustable blades
- back row of horizontal individually adjustable blades
- frame and blades made out of galvanized steel
- fixing with screws
- installation on round duct

Standard dimensions steel grille

B	225 - 1225 mm, in increments 100mm
H	75, 125 or 225 mm

* B > H

*Options
**Installation

pg. 19
pg. 20

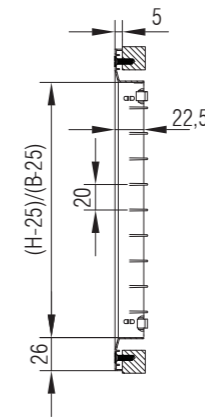

STEEL GRILLES

CRH 1

- frame and blades made out of galvanized steel
- one row of horizontal individually adjustable blades
- fixing with visible screws (wall and ceiling)
- fixing without visible screws (UR) only in wall

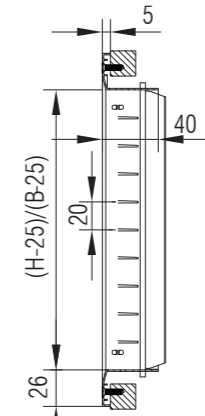

CRH 2

- frame and blades made out of galvanized steel
- front row of horizontal individually adjustable blades
- back row of vertical individually adjustable blades
- fixing with visible screws (wall and ceiling)
- fixing without visible screws (UR) only in wall

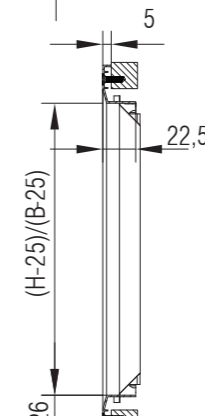

CRV 1

- frame and blades made out of galvanized steel
- one row of vertical individually adjustable blades
- fixing with visible screws (wall and ceiling)
- fixing without visible screws (UR) only in wall

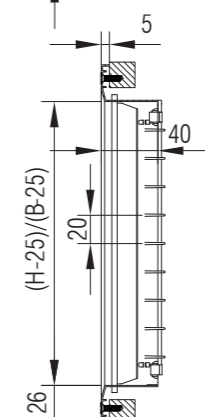
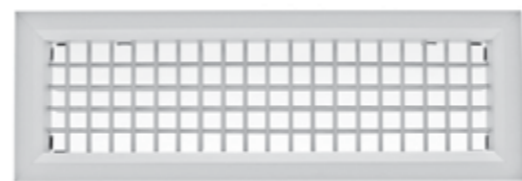

CRV 2

- frame and blades made out of galvanized steel
- front row of vertical individually adjustable blades
- back row of horizontal individually adjustable blades
- fixing with visible screws (wall and ceiling)
- fixing without visible screws (UR) only in wall

*Options pg. 19
**Installation pg. 20
***Standard dimensions pg. 13

Linear grille (B > 1225mm)

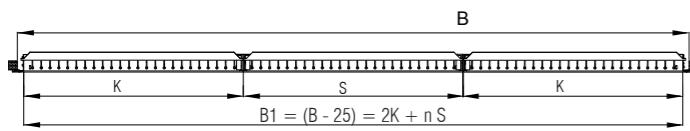
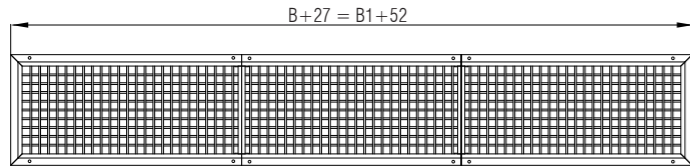

* K – end section
 S – connecting section
 n – number of connecting sections
 (1200 < B1 < 2400) – two end sections
 (B1 > 2400) – two end sections and n connecting sections

Inline connection of subframes

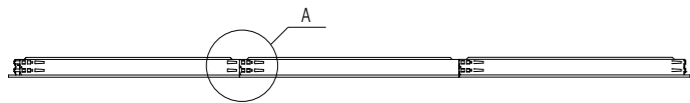

Linear grille OAB1-0 + BxH (B1 > 2400mm)

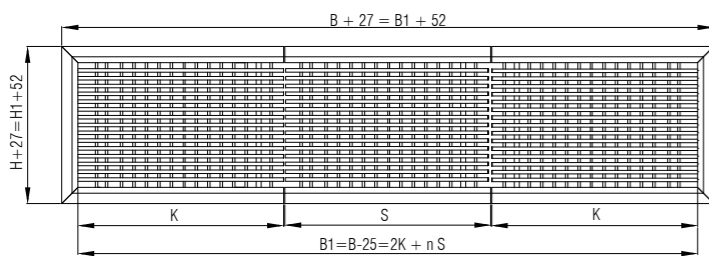

LINEAR GRILLES

OAV, OAB

- for width more than 1225mm
- fixing with screws
- standard sizes H: 75, 125, 225, 325

Options

- installation subframe
- flow damper
- plenum box
- installation subframe and damper made from multiple parts

Detail A (subframe joint)

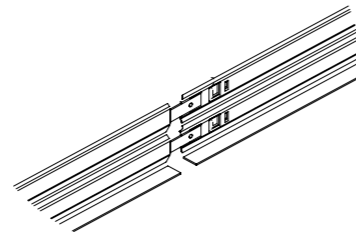

FLOOR GRILLES

NRA 0

- frame and blades made out of anodized aluminium profiles
- one row of fixed horizontal blades
- blade insert detachable from the frame
- fixing in floor

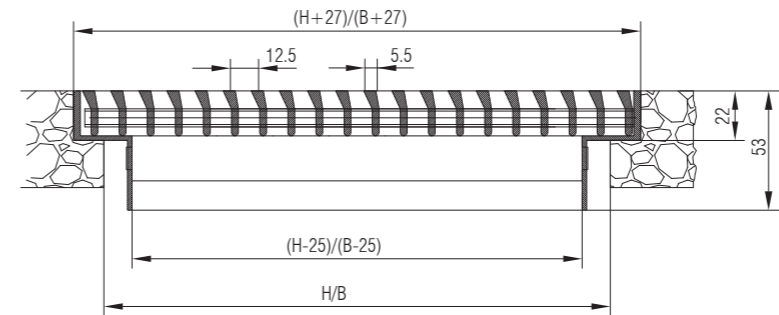
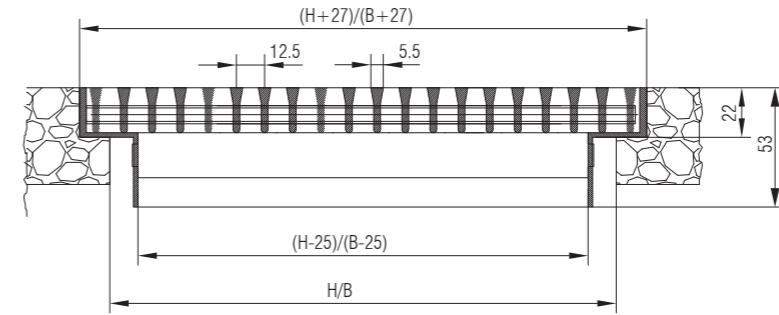

NRA 15

- frame and blades made out of anodized aluminium profiles
- one row of fixed horizontal blades
- blade insert detachable from the frame
- fixing in floor

Standard dimensions for floor grilles NRA

B	225 - 1225 mm, in increments of 100mm
H	125 - 525 mm, in increments of 100mm

* B > H



NRK

- frame and blades made out of anodized aluminium profiles
- one row of fixed horizontal blades
- blade insert detachable from the frame
- fixing in floor
- standard widths: 254, 344, 444mm, other widths on special demand
- maximum grille length, 6m

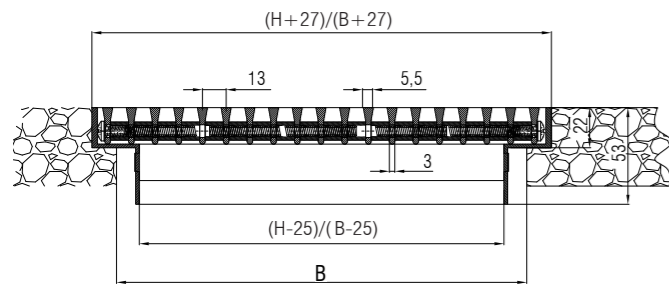

DAMPERS

L - damper

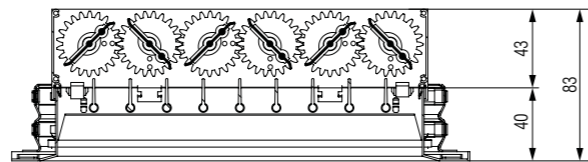
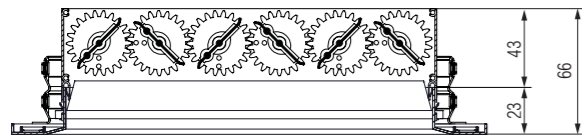

S - damper

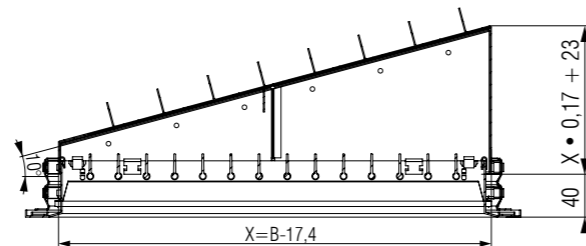
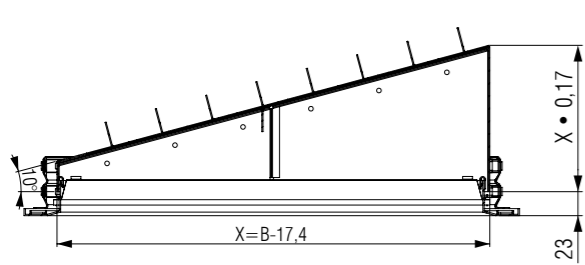

OPTIONS

GRILLE	OPTIONS						
	Damper		Installation with subframe	RAL....	Linear grille B > 1225mm	Plenum box PK1, PK2, PK3	Removable filter insert
	L	S					
OAH	•	•	•	•		•	•
OAV	•	•	•	•	•	•	•
OAB	•	•	•	•	•	•	•
OAS			•	•			
OAS-R				•			
OAK	•	•	•	•		•	•
OAN	•		•	•		•	•
OAM	•	•	•	•		•	•
OCM	•	•	•	•		•	•
CCH	•	•	•	•			
CCV	•	•	•	•			
NRA	•		•	•	•	•	
NRB	•		•	•	•	•	
NRE	•		•	•			
NRK			•	•	•	•	
PCR				•			•
ORP				•			•
PTR			•	•		•	

Ordering key:

Grille type **OAH1 - L - UR - 425x125 - G2 - RAL..**
 Damper type
 Installation subframe
 Dimensions
 Filter G2..G4

* Screws are not supplied with grilles

INSTALLATION INSTRUCTIONS

Wall installation

- without subframe

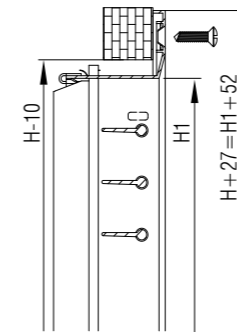

- with subframe

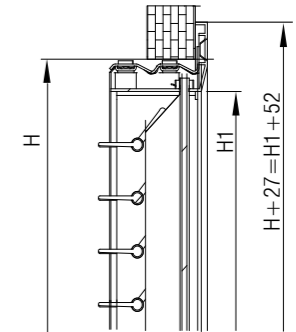

Subframe installation

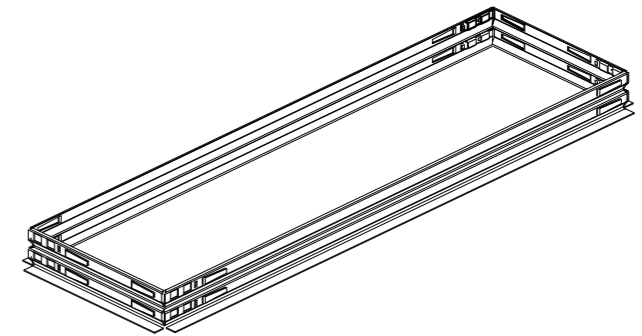
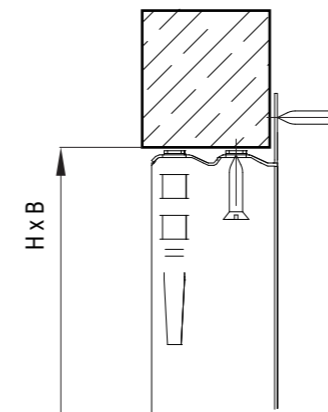

Ceiling installation

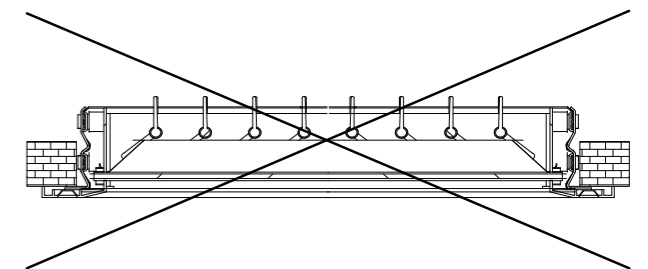
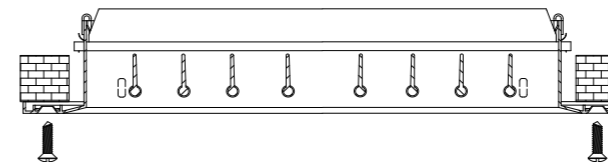

* Screws are not supplied with grilles
 * Screws for grille fastening 3,9xL (DIN 7972, 7973, 7982, 7983)

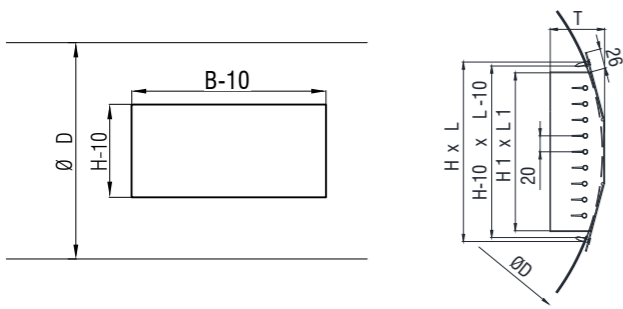

Installation CCV, CCH

- Note: make sure that the grille height H fits for installation on a round duct with diameter ϕD

B [mm]	H [mm]	T [mm]	ϕD [mm]	B [mm]	H [mm]	T [mm]	ϕD [mm]	B [mm]	H [mm]	T [mm]	ϕD [mm]
225	x	75	150	225	x	125	300	225	x	225	600
325	x	75	40	325	x	125	45	325	x	225	55
425	x	75		425	x	125		425	x	225	
525	x	75		525	x	125		525	x	225	
625	x	75		625	x	125		625	x	225	
825	x	75		825	x	125		825	x	225	
1125	x	75		1125	x	125		1125	x	225	
			400				900				2400

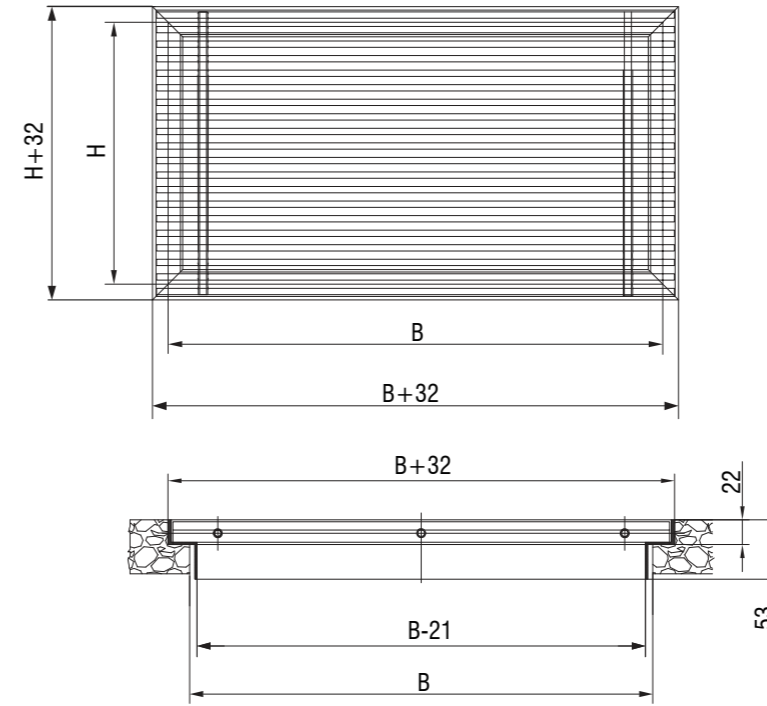

NRA and NRK installation

- fix the frame in the floor opening
- grille core is laid loose in the frame so it can be easily removed

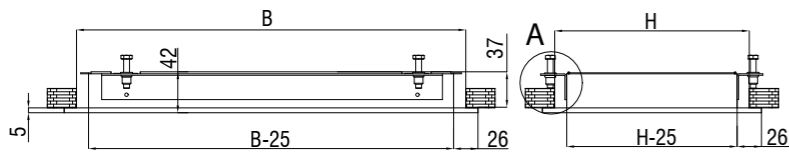
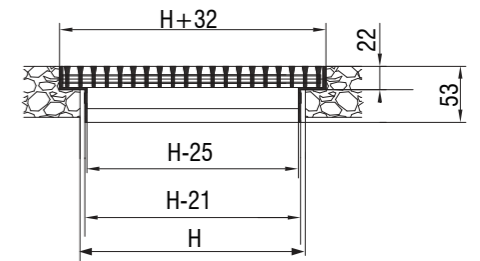

ORP installation

- First, the grille subframe is placed into the ceiling and then the bracelets suspension are fixed to the inner side of the ceiling.
- Perforated plate is then pushed through the installation subframe above the ceiling, to be finally lowered to the frame.

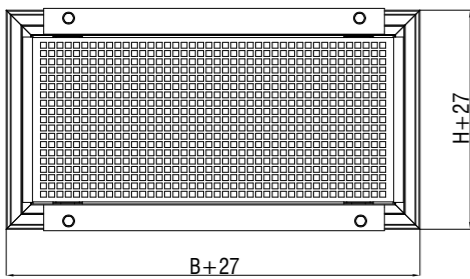

Detail A

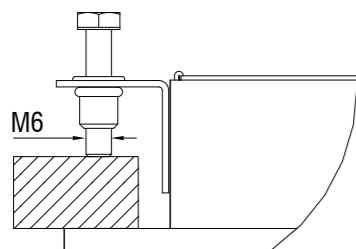

PLENUM BOX - PK1

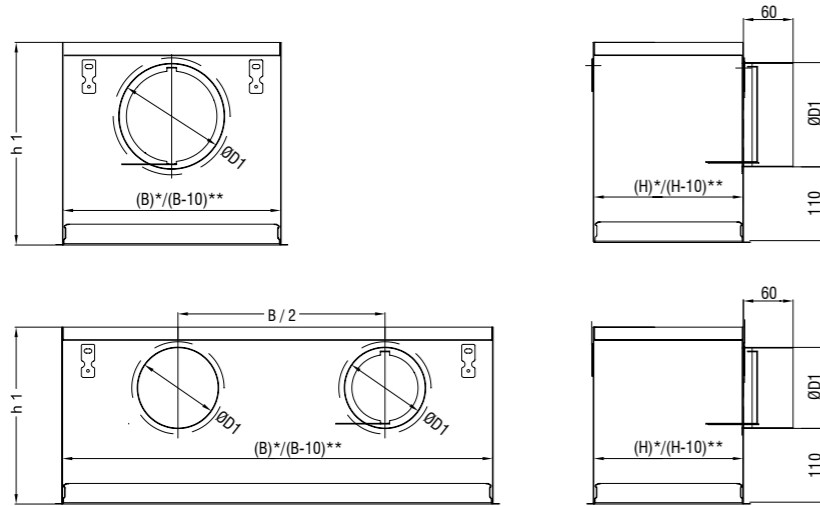

PK1 / PK1-UR				
B mm	H mm	ØD mm	Number of connections	h1 mm
225	75	123	1	265
325	75	158	1	300
425	75	158	1	300
525	75	158	1	300
625	75	158	1	300
725	75	158	1	300
825	75	158	2	300
925	75	158	2	300
1025	75	158	2	300
1125	75	158	2	300
1225	75	158	2	300
225	125	158	1	300
325	125	158	1	300
425	125	158	1	300
525	125	158	1	300
625	125	158	1	300
725	125	158	1	300
825	125	158	2	300
925	125	158	2	300
1025	125	158	2	300
1125	125	158	2	300
1225	125	158	2	300
225	225	158	1	300
325	225	158	1	300
425	225	198	1	340
525	225	198	1	340
625	225	198	1	340
725	225	198	1	340
825	225	198	2	340
925	225	198	2	340
1025	225	198	2	340
1125	225	198	2	340
1225	225	198	2	340

Note:

- * Dimensions PK for installation with subframe
- ** Dimensions PK for installation without subframe

PK1 / PK1-UR				
B mm	H mm	ØD mm	Number of connections	h1 mm
325	325	248	1	390
425	325	248	1	390
525	325	248	1	390
625	325	248	1	390
725	325	248	1	390
825	325	248	2	390
925	325	248	2	390
1025	325	248	2	390
1125	325	248	2	390
1225	325	248	2	390
425	425	248	1	390
525	425	248	1	390
625	425	248	1	390
725	425	248	1	390
825	425	248	2	390
925	425	248	2	390
1025	425	248	2	390
1125	425	248	2	390
1225	425	248	2	390
525	525	313	1	455
625	525	313	1	455
725	525	313	1	455
825	525	313	2	455
925	525	313	2	455
1025	525	313	2	455
1125	525	313	2	455
1225	525	313	2	455

Ordering key:

Plenum box type **PK1 - UR - 525x225 - Z**
 Installation subframe
 Dimensions
 Insulation

PLENUM BOX - PK2

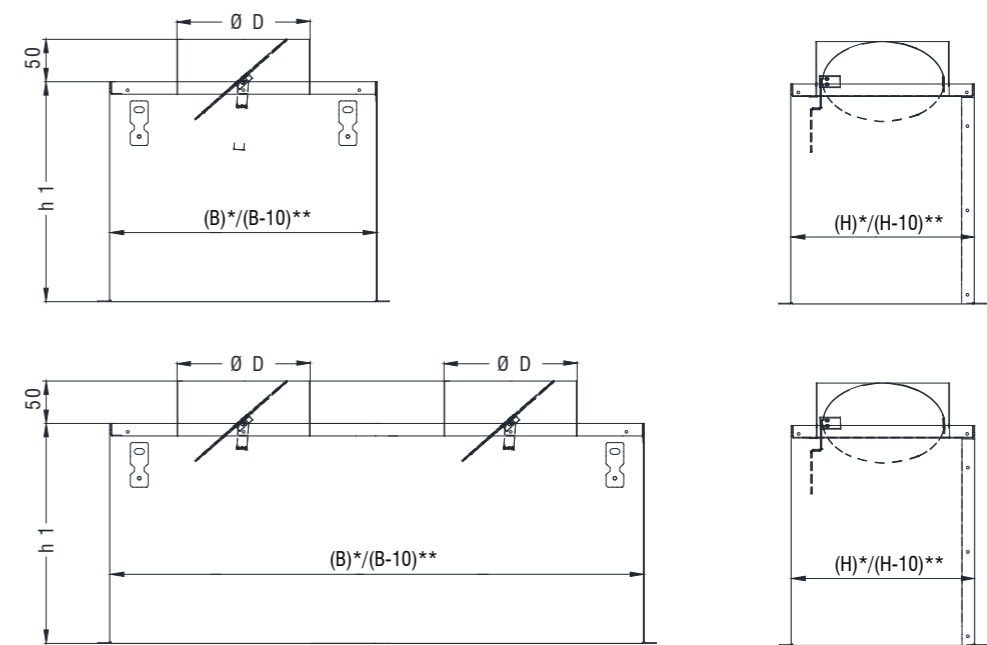

PK2 / PK2-UR				
B mm	H mm	ØD mm	Number of connections	h1 mm
225	125	98	2	250
325	125	98	2	250
425	125	98	2	250
525	125	98	3	250
625	125	98	3	250
725	125	98	3	250
825	125	98	3	250
925	125	98	3	250
1025	125	98	3	250
1125	125	98	3	250
1225	125	98	3	250
225	225	158	1	300
325	225	198	1	340
425	225	198	1	340
525	225	198	1	340
625	225	198	2	340
725	225	198	2	340
825	225	198	2	340
925	225	198	2	340
1025	225	198	2	340
1125	225	198	2	340
1225	225	198	2	340
325	325	248	1	390
425	325	248	1	390
525	325	248	1	390
625	325	248	1	390
725	325	248	1	390
825	325	248	2	390
925	325	248	2	390
1025	325	248	2	390
1125	325	248	2	390
1225	325	248	2	390

PK2 / PK2-UR				
B mm	H mm	ØD mm	Number of connections	h1 mm
425	425	248	1	390
525	425	248	1	390
625	425	248	1	390
725	425	248	1	390
825	425	248	2	390
925	425	248	2	390
1025	425	248	2	390
1125	425	248	2	390
1225	425	248	2	390
525	525	313	1	455
625	525	313	1	455
725	525	313	1	455
825	525	313	2	455
925	525	313	2	455
1025	525	313	2	455
1125	525	313	2	455
1225	525	313	2	455

Ordering key:

Plenum box type **PK2 - UR - 525x225 - Z**
 Installation subframe
 Dimensions
 Insulation

Note:

- * Dimensions PK for installation with subframe
- ** Dimensions PK for installation without subframe

PLENUM BOX - PK3

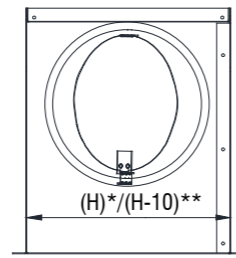
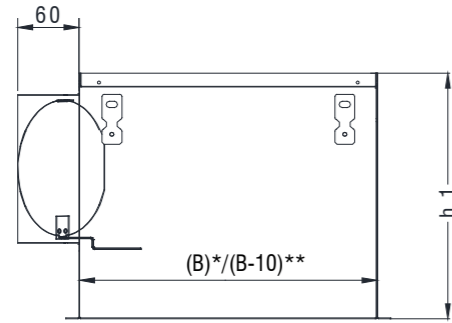

PK3 / PK3-UR				
B mm	H mm	øD mm	Number of connections	h1 mm
225	125	98	2	250
325	125	98	2	250
425	125	98	2	250
525	125	98	3	250
625	125	98	3	250
725	125	98	3	250
825	125	98	3	250
925	125	98	3	250
1025	125	98	3	250
1125	125	98	3	250
1225	125	98	3	250
225	225	158	1	300
325	225	198	1	340
425	225	198	1	340
525	225	198	1	340
625	225	198	2	340
725	225	198	2	340
825	225	198	2	340
925	225	198	2	340
1025	225	198	2	340
1125	225	198	2	340
1225	225	198	2	340
325	325	248	1	390
425	325	248	1	390
525	325	248	1	390
625	325	248	1	390
725	325	248	1	390
825	325	248	2	390
925	325	248	2	390
1025	325	248	2	390
1125	325	248	2	390
1225	325	248	2	390

PK3 / PK3-UR				
B mm	H mm	øD mm	Number of connections	h1 mm
425	425	248	1	390
525	425	248	1	390
625	425	248	1	390
725	425	248	1	390
825	425	248	2	390
925	425	248	2	390
1025	425	248	2	390
1125	425	248	2	390
1225	425	248	2	390
525	525	313	1	455
625	525	313	1	455
725	525	313	1	455
825	525	313	2	455
925	525	313	2	455
1025	525	313	2	455
1125	525	313	2	455
1225	525	313	2	455

Ordering key:

Plenum box type **PK3 - UR - 525x225 - Z**

Installation subframe

Dimensions

Insulation

Note:

* Dimensions PK for installation with subframe

** Dimensions PK for installation without subframe

EFFECTIVE SUPPLY AREA TABLE - A_{ef} (m²)

OAH, OAV, CCH, CCV								
H ↓ B →	225	325	425	525	625	825	1025	1225
75	0,0070	0,0110	0,0150	0,0180	0,0220	0,0290	0,0360	0,0430
125	0,0150	0,0220	0,0290	0,0360	0,0440	0,0580	0,0730	0,0870
225	-	0,0410	0,0590	0,0730	0,0870	0,1160	0,1450	0,1740
325	-	-	0,0880	0,1090	0,1310	0,1740	0,2170	0,2610
425	-	-	-	-	0,1750	0,2320	0,2900	0,3480
525	-	-	-	-	-	-	0,3620	0,4340

OAB, NRA								
H ↓ B →	225	325	425	525	625	825	1025	1225
75	0,0060	0,0090	0,0110	0,0140	0,0170	0,0220	0,0280	0,0340
125	0,0110	0,0170	0,0220	0,0280	0,0340	0,0440	0,0550	0,0660
225	-	0,0340	0,0440	0,0550	0,0660	0,0870	0,1080	0,1290
325	-	-	0,0660	0,0810	0,0960	0,1290	0,1690	0,1930
425	-	-	-	-	0,1290	0,1690	0,2140	0,2560
525	-	-	-	-	-	-	0,2688	0,3264

OCM								
H ↓ B →	225	325	425	525	625	825	1025	1225
75	-	-	-	-	-	-	-	-
125	0,0085	0,0128	0,0170	0,0213	0,0255	0,0340	0,0425	0,0510
225	0,0170	0,0255	0,0340	0,0425	0,0510	0,0680	0,0850	0,1020
325	0,0255	0,0383	0,0510	0,0638	0,0765	0,1020	0,1275	0,1530
425	0,034	0,0510	0,0680	0,0850	0,1020	0,1360	0,1700	0,2040
525	-	-	-	0,1063	0,1275	0,1700	0,2125	0,2550

OAM								
H ↓ B →	225	325	425	525	625	825	1025	1225
75	-	-	-	-	-	-	-	-
125	0,0033	0,0050	0,0067	0,0083	0,0100	0,0133	0,0166	0,0200
225	0,0067	0,0100	0,0133	0,0166	0,0200	0,0266	0,0333	0,0399
325	0,0100	0,0150	0,0200	0,0250	0,0300	0,0399	0,0499	0,0599
425	0,0133	0,0200	0,0266	0,0333	0,0399	0,0533	0,0666	0,0799
525	-	-	-	0,0416	0,0499	0,0667	0,0832	0,0998

PTR								
H ↓ B →	225	325	425	525	625	825	1025	1225
75	0,0070	0,0100	0,0140	0,0170	0,0210	0,0260	0,0340	0,0390
125	0,0130	0,0190	0,0250	0,0310	0,0380	0,0500	0,0630	0,0750
225	0,0240	0,0340	0,0500	0,0610	0,0740	0,0970	0,1210	0,1460
325	-	0,0520	0,0720	0,0880	0,1060	0,1390	0,1740	0,2080
425	-	-	0,0970	0,1200	0,1420	0,1880	0,2340	0,2610
525	-	-	-	0,1520	0,1800	0,2360	0,2920	0,3510

EFFECTIVE EXHAUST AREA TABLE - A_{ef} (m²)

OAH, OAV, CCH, CCV								
H ↓ B →	225	325	425	525	625	825	1025	1225
75	0,006	0,009	0,011	0,014	0,016	0,022	0,028	0,033
125	0,011	0,016	0,022	0,028	0,033	0,044	0,055	0,066
225	-	0,033	0,044	0,055	0,066	0,090	0,110	0,134
325	-	-	0,066	0,083	0,100	0,134	0,170	0,200
425	-	-	-	-	0,134	0,180	0,220	0,270
525	-	-	-	-	-	-	0,280	0,340

OAB, NRA								
H ↓ B →	225	325	425	525	625	825	1025	1225
75	0,006	0,009	0,011	0,014	0,016	0,022	0,028	0,033
125	0,011	0,016	0,022	0,028	0,033	0,044	0,055	0,066
225	-	0,033	0,044	0,055	0,066	0,090	0,110	0,134
325	-	-	0,066	0,083	0,100	0,134	0,170	0,200
425	-	-	-	-	0,134	0,180	0,220	0,270
525	-	-	-	-	-	-	0,280	0,340

OAK								
H ↓ B →	225	325	425	525	625	825	1025	1225
75								
125	0,012	0,018	0,025	0,031	0,038	0,050	0,063	0,075
225	-	0,038	0,050	0,063	0,075	0,105	0,126	0,155
325	-	-	0,075	0,096	0,117	0,155	0,197	0,236
425	-	-	-	-	0,155	0,210	0,260	0,310
525	-	-	-	-	-	-	0,330	0,400

OAN								
H ↓ B →	225	325	425	525	625	825	1025	1225
75	0,006	0,01	0,013	0,016	0,019	0,026	0,032	0,038
125	0,009	0,014	0,019	0,024	0,029	0,038	0,048	0,057
225	-	0,032	0,043	0,053	0,064	0,086	0,107	0,129
325	-	-	0,066	0,083	0,100	0,134	0,167	0,200
425	-	-	-	-	0,136	0,181	0,227	0,272
525	-	-	-	-	-	-	0,287	0,344

EFFECTIVE EXHAUST AREA TABLE - A_{ef} (m²)

OCM								
H ↓ B →	225	325	425	525	625	825	1025	1225
75	-	-	-	-	-	-	-	-
125	0,0085	0,0128	0,0170	0,0213	0,0255	0,0340	0,0425	0,0510
225	0,0170	0,0255	0,0340	0,0425	0,0510	0,0680	0,0850	0,1020
325	0,0255	0,0383	0,0510	0,0638	0,0765	0,1020	0,1275	0,1530
425	0,0340	0,0510	0,0680	0,0850	0,1020	0,1360	0,1700	0,2040
525	-	-	-	0,1063	0,1275	0,1700	0,2125	0,2550

PCR								
H ↓ B →	225	325	425	525	625	825	1025	1225
75	-	-	-	-	-	-	-	-
125	0,0049	0,0076	0,0103	0,0130	0,0158	0,0212	0,0266	0,320
225	-	0,0171	0,0232	0,0293	0,0354	0,0477	0,0599	0,0721
325	-	-	0,0361	0,0456	0,0551	0,0741	0,0932	0,1122
425	-	-	-	0,0619	0,0748	0,1006	0,1264	0,1522
525	-	-	-	0,0782	0,0945	0,1271	0,1597	0,1923

OAS								
H ↓ B →	225	325	425	525	625	825	1025	1225
75	0,0040	0,0059	0,0079	0,0099	0,0119	0,0158	0,0199	0,0239
125	0,0079	0,0119	0,0158	0,0199	0,0239	0,0321	0,0397	0,0476
225	0,0158	0,0239	0,0318	0,0397	0,0476	0,0635	0,0794	0,0952
325	-	0,0357	0,0476	0,0598	0,0715	0,0952	0,1191	0,1429
425	-	-	0,0635	0,0794	0,0952	0,1270	0,1588	0,1905
525	-	-	-	0,1042	0,1240	0,1637	0,2034	0,2431

ORP								
B [mm]	500	600	700	800	900	1000	1100	1200
H [mm]	500	600	700	800	900	1000	1100	1200
A_{ef} [m ²]	0,099	0,147	0,204	0,270	0,346	0,431	0,525	0,629

SELECTION DIAGRAMS

1.1 Selection diagrams for supply air grilles: OAH, OAV, CCH, CCV

H	B →
525	1025 1225
425	625 825 1025 1225
325	425 525 625 825 1025 1225
225	325 425 525 625 825 1025 1225
125	225 325 425 525 625 825 1025 1225
75	225 325 425 525 625 825 1025 1225

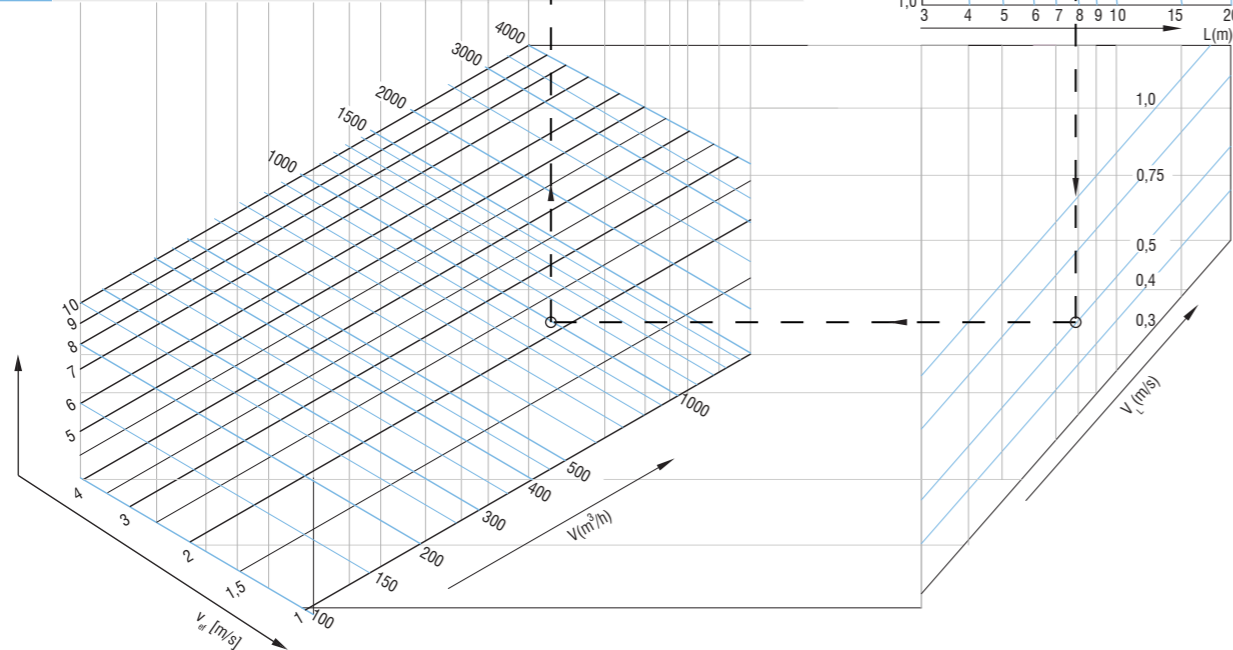
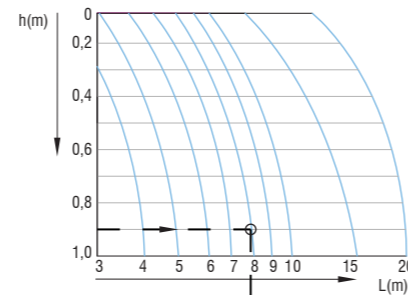

1.2 Induction diagram

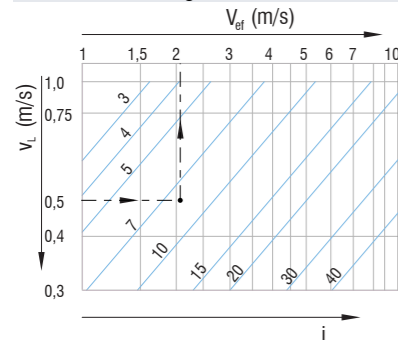

Example:

Given:
 L = 8 m
 V = 1000 m³/h
 v_L = 0,5 m/s
 Δt_z = 4K
 h = 0,9 m

Grille type : OAV

Select:

From 1.1 :
 BxH 625x325;
 A_ef = 0,131 m²;
 v_ef = 2,2 m/s;
 From 1.2 :
 i = 8;
 From 1.3 :
 Sound power level
 (50% open): 24 dB (A);
 Correction: 24+1 = 25 dB(A);

From 2.6 :
 b_{0,2} = 0,9 m;
 From Δt_L = k * Δt_z * (v_L / v_ef)
 Δt_L = 0,68 K;
 From 2.7 and 2.8:
 k = 0,85
 y = k * Δt_z = 3,4 m
 Horizontal distance
 D > 0,2 L > 1,6m

1.3 Air pressure drop and sound power level OAH, OAV, CCH, CCV

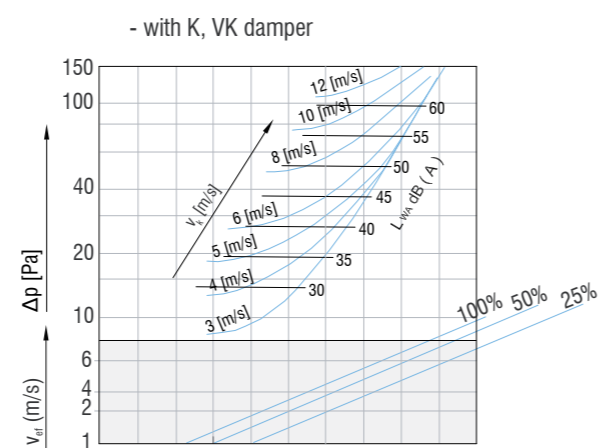
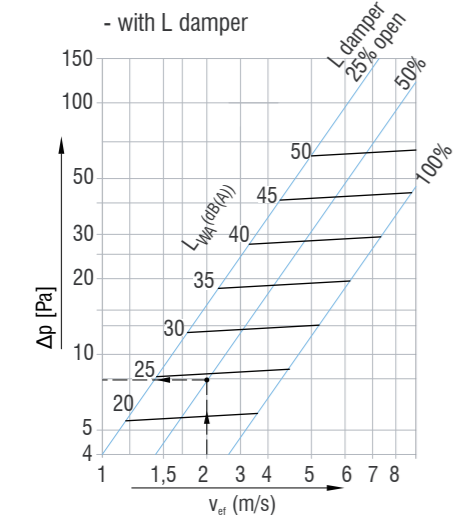

1.4 Selection diagrams for exhaust air grilles: OAB, NRA, NRK

H	B →
425	625 825 1025 1225
325	425 525 625 825 1025 1225
225	325 425 525 625 825 1025 1225
125	225 325 425 525 625 825 1025 1225
75	225 325 425 525 625 825 1025 1225

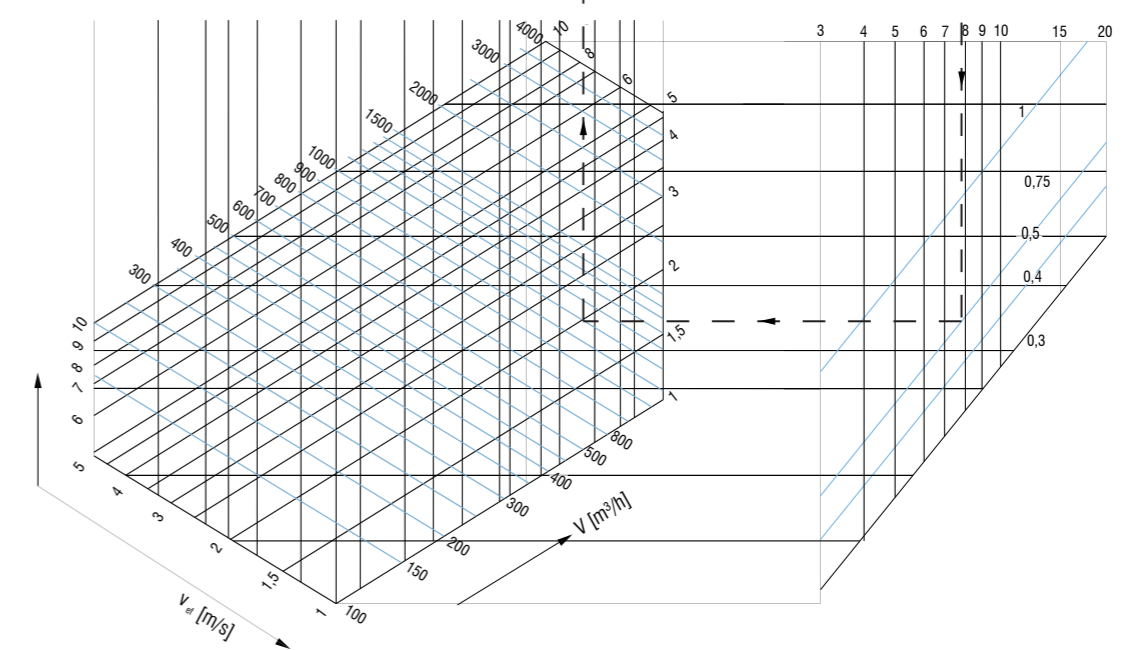
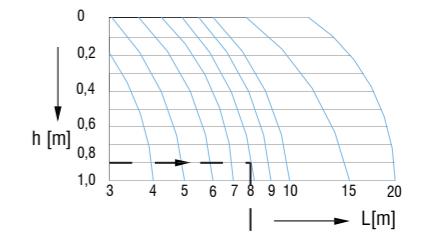

1.5 Induction diagram

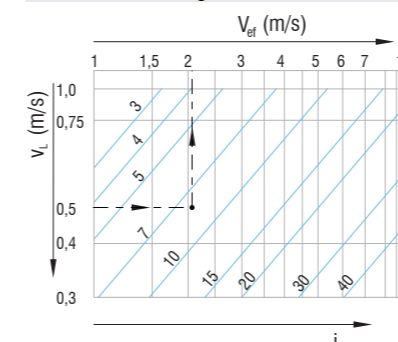

Example:

Given:
 L = 8 m
 V = 1000 m³/h
 v_L = 0,5 m/s
 Δt_z = 4K
 h = 0,9 m
 Grille type : OAB

Select:

From 1.1 :
 BxH 825x325;
 A_ef = 0,129 m²;
 v_ef = 2 m/s;
 From 1.2 :
 i = 8;
 From 1.3 :
 Sound power level
 (50% open): 24 dB (A);
 Correction: 24+0 = 24 dB(A);

From 2.6 :
 b_{0,2} = 0,9 m;
 From Δt_L = k * Δt_z * (v_L / v_ef)
 Δt_L = 0,68 K;
 From 2.7 and 2.8:
 k = 0,85
 y = k * Δt_z = 3,4 m
 Horizontal distance
 D > 0,2 L > 1,6m

1.6 Air pressure drop and sound power level OAB, NRA, NRK

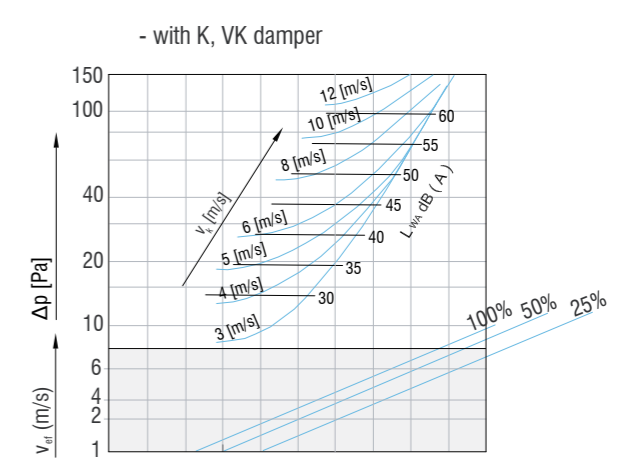
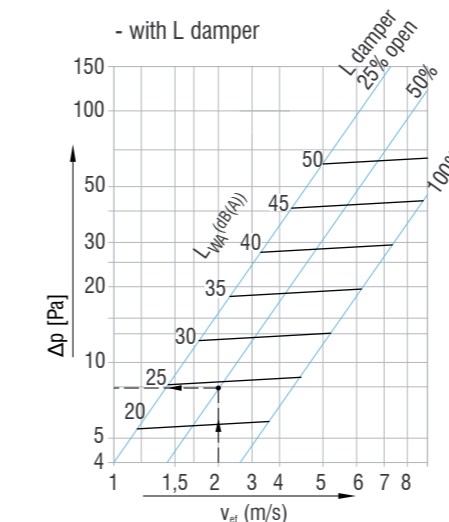

1.7 Selection diagrams for supply air grilles: OAB, NRA, NRK

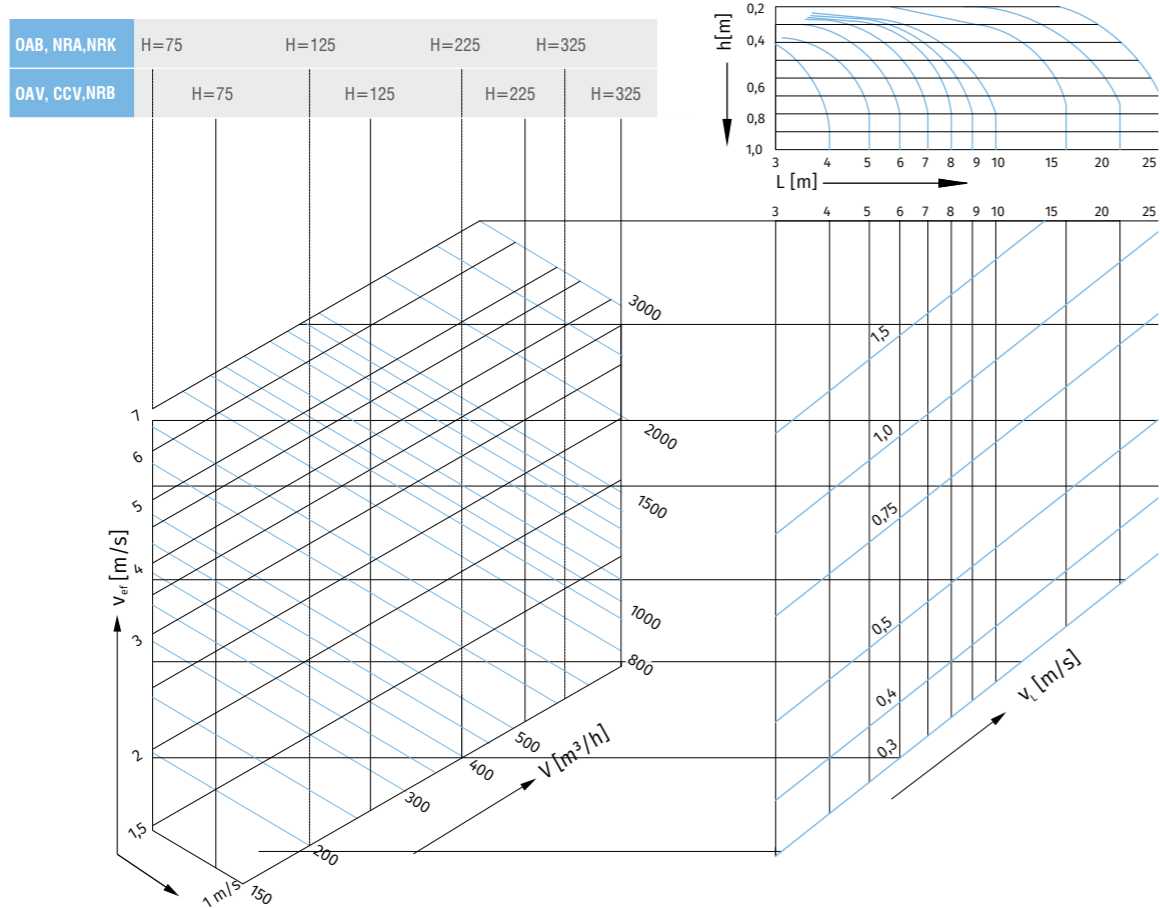

1.8 Induction diagram

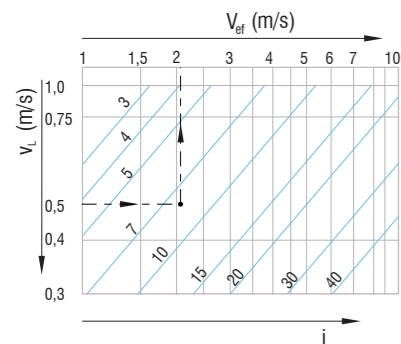

1.9 Air pressure drop and sound power level for linear grilles OAB, NRA, NRK

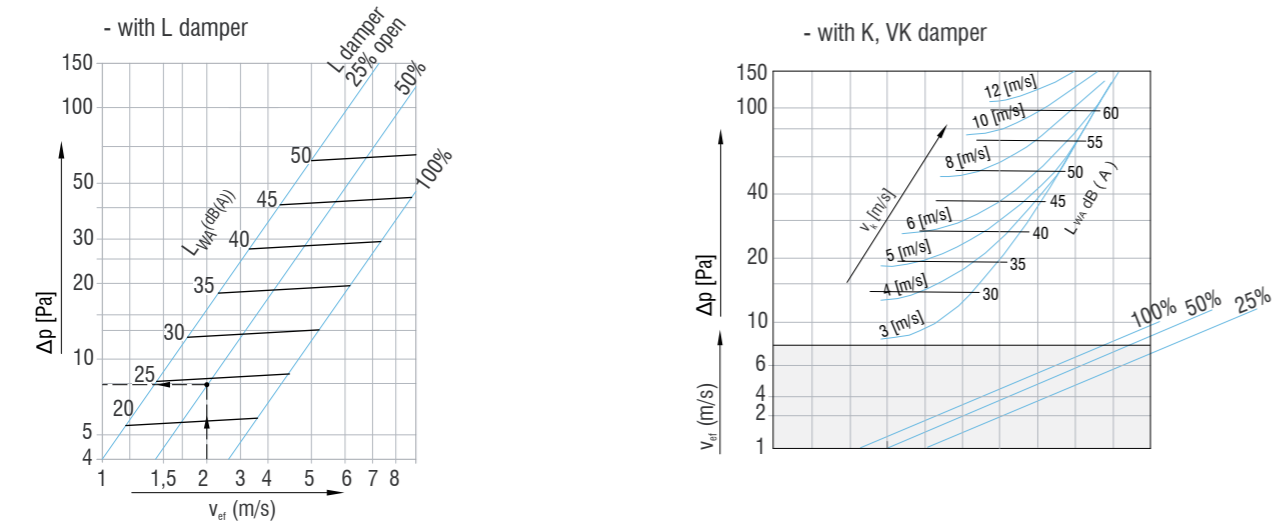

2.0 Selection diagrams for exhaust air grilles: OAH, OAV, CCH, CCV, OAB OAN, NRA, NRK

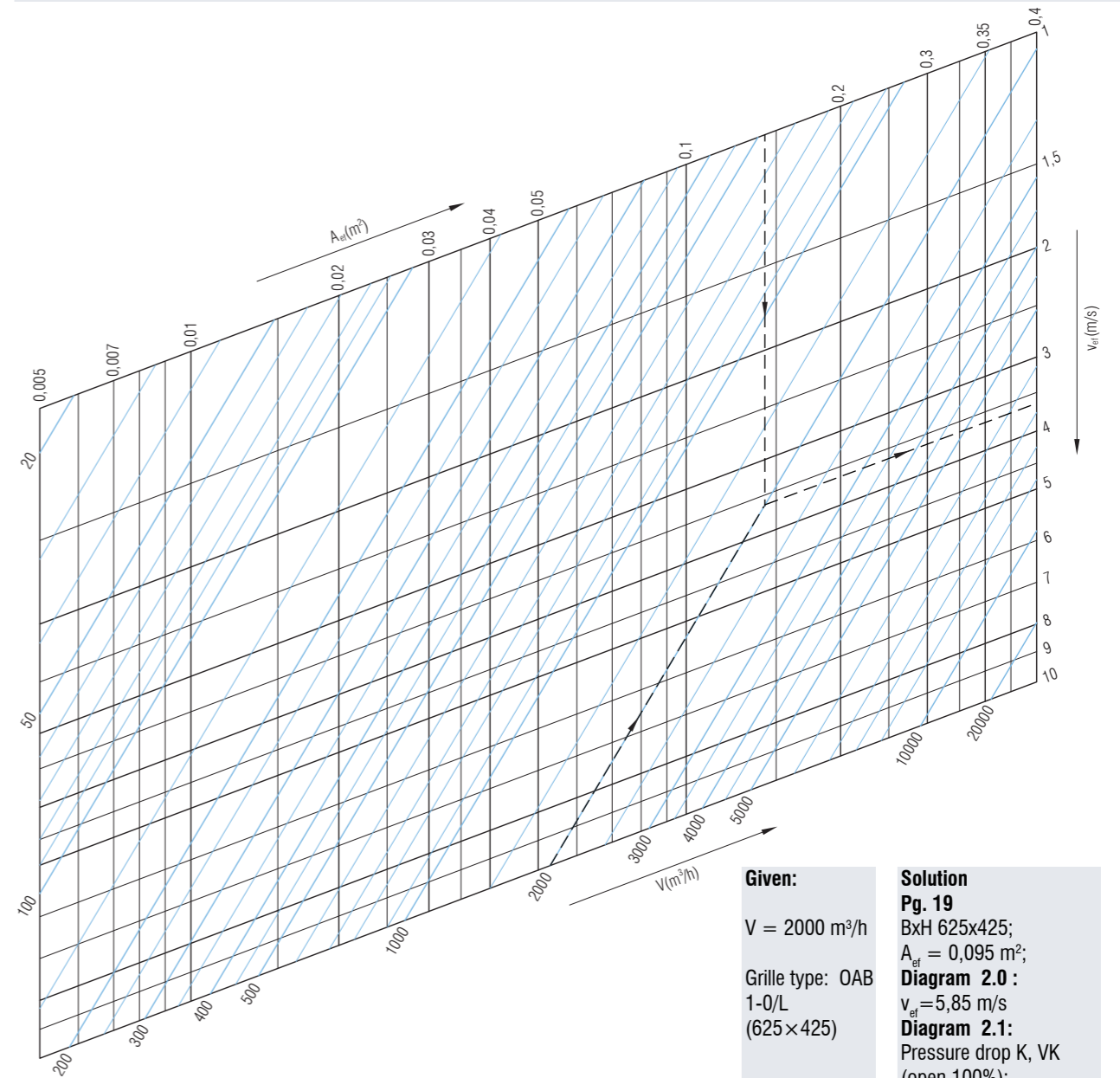

Given:
 $V = 2000 \text{ m}^3/\text{h}$
 Grille type: OAB
 1-0/L
 (625x425)

Solution Pg. 19
 BxH 625x425;
 $A_{gr} = 0,095 \text{ m}^2$;
Diagram 2.0:
 $v_{gr} = 5,85 \text{ m/s}$
Diagram 2.1:
 Pressure drop K, VK
 (open 100%):
 $\Delta p = 12 \text{ Pa}$

2.1 Air pressure drop and sound power level

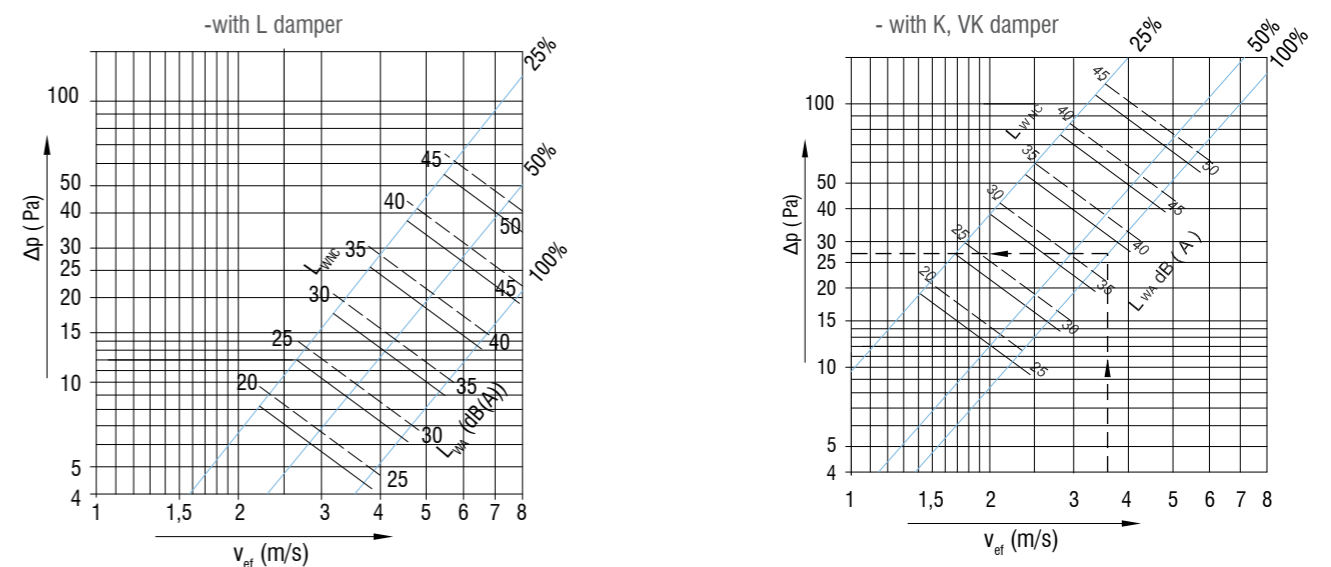

2.2 Selection diagram for PTR grille

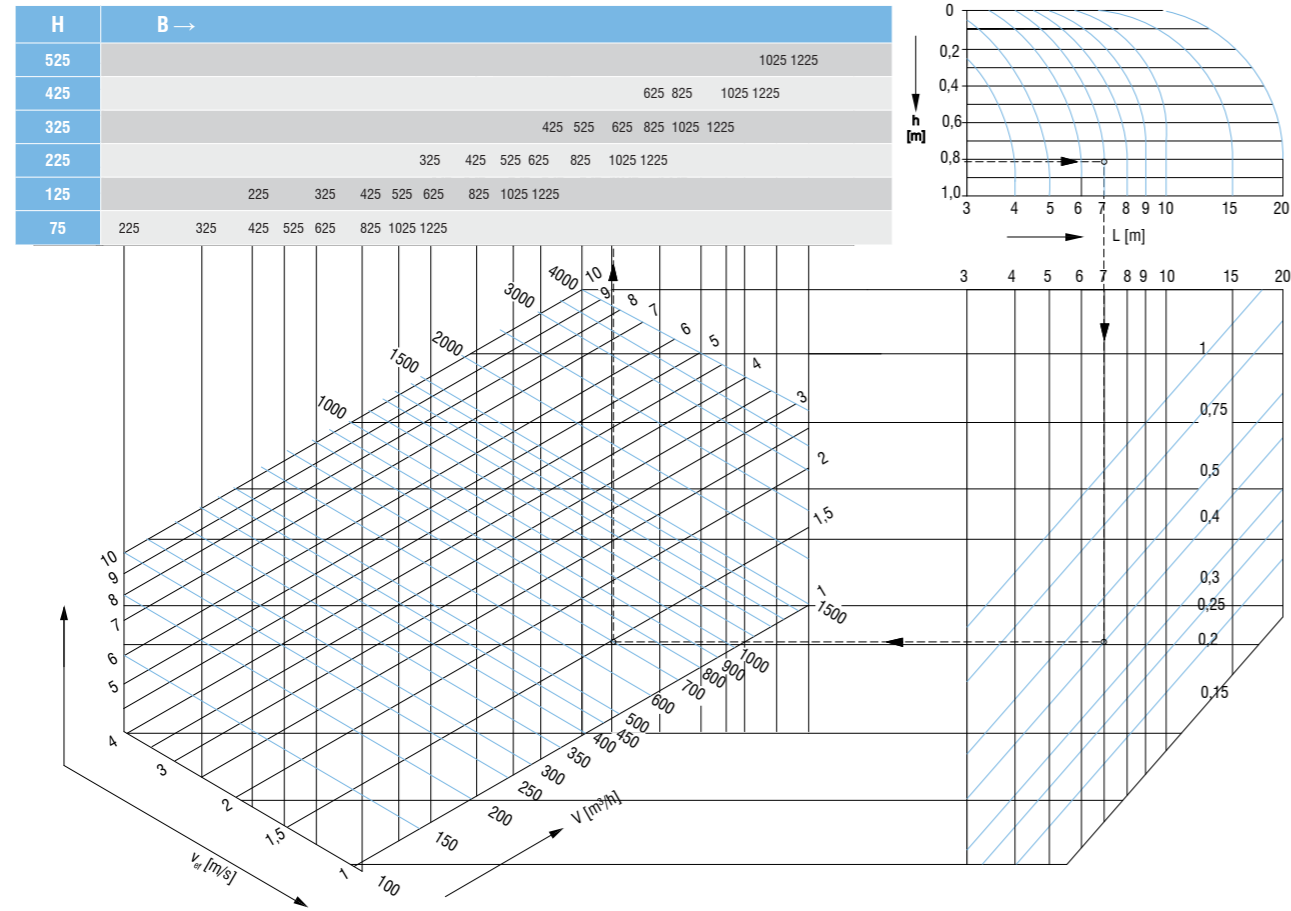

2.3 Air pressure drop and sound power level for PTR grille with L-damper

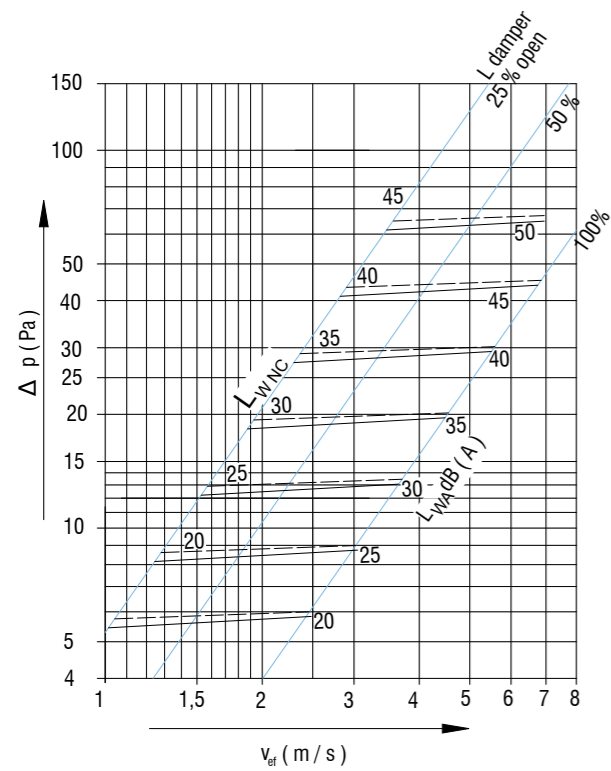

2.4 Pressure drop for PCR grille without filter

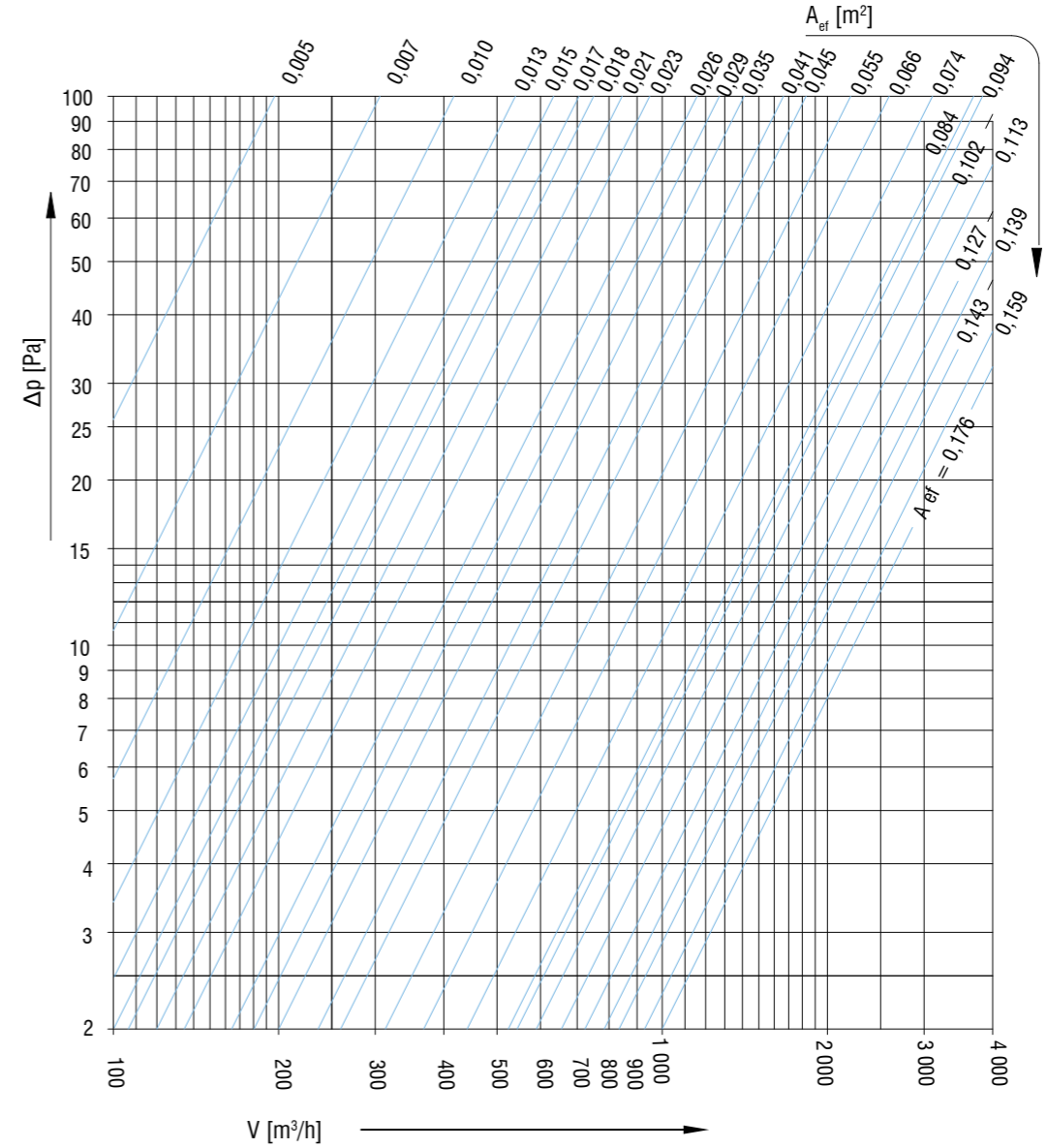
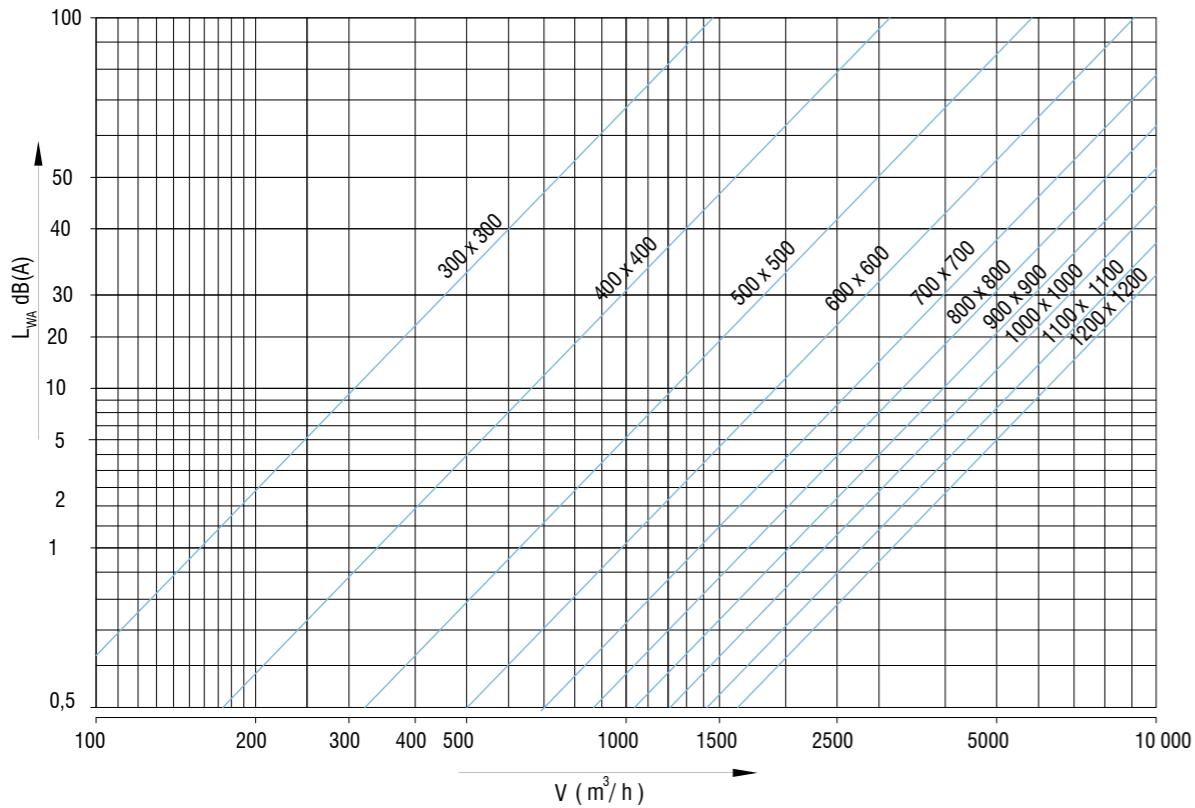

Table of additional pressure loss for PCR grille with filter

V_{ef} (m/s)	Filter G2		Filter G4	
	Δp_1 (Pa)	Δp_2 (Pa)	Δp_1 (Pa)	Δp_2 (Pa)
	Initial	End	Initial	End
1	4	114	6	176
2	6	116	9	179
3	8	118	12	182
4	10	120	15	185
5	12	122	18	188
6	14	124	21	191
7	16	126	24	194
8	18	128	27	197
9	20	130	30	200
10	21	131	34	204
11	23	133	37	207
12	24	134	41	211

2.5 Diagram of sound power level for ORP grille



Correction table for sound power levels

A_{ef} (m ²)	0,005	0,01	0,02	0,05	0,1	0,2	0,4
ΔL_s	-13	-10	-7	-3	0	3	6

L_{WA} dB [A] - Sound power level on grille ($A_{ef} = 0,1$)

L_{WA} dB [A] = $L_{WA, 0,1 m^2} + \Delta L_s$

ΔL_s [dB] - Sound power correction $A_{ef} \neq 0,1$ (m²)

Correction values for blade deflection

Blade divergence angle	β	90°	45°
Jet dissipation angle	α	60°	35°
Max. jet velocity	v_L	0,5 x v_L	0,7 x v_L
Max. temperature difference	$\Delta t_L / \Delta t_z$	0,5 x	0,7 x
Induction	i	2 x i	1,4 x i
Distance between two neighbouring grille. Case A - free discharge	D	> 0,3L	> 0,25L
Distance between two grille. Case B - discharge with Coanda effect	D	> 0,3L	> 0,25L
Jet deflection	y	2 x y	1,4 x y

Pressure drop for grilles that are not mentioned in diagrams above (OAM, OCM and OAS)

OAM/OCM → $\Delta p = 0,67194 \times v_{ef}^2$

OAS → $\Delta p = 3,72 \times v_{ef}^2$

2.6 Jet width diagram $b_{0,2}$ (for $h > 0,8m$)

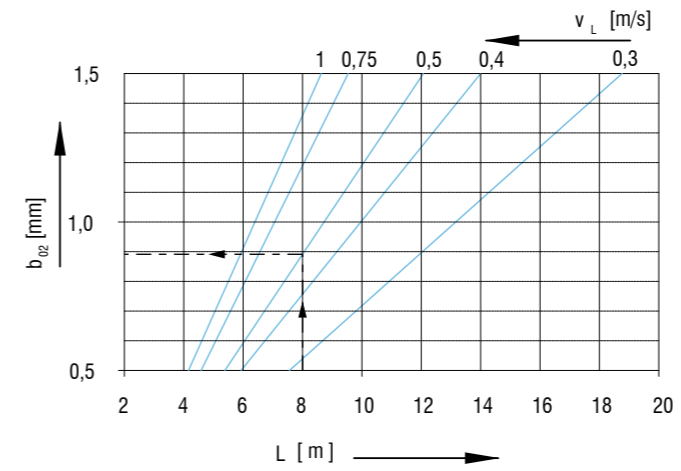

$\Delta t_L = k_1 \times \Delta t_z \times (v_L / v_{ef})$

$k_1 = 0,9$ $h \leq 0,3$ m

$k_1 = 0,75$ $h \geq 0,8$ m

2.6a Jet deflection because of Δt_z

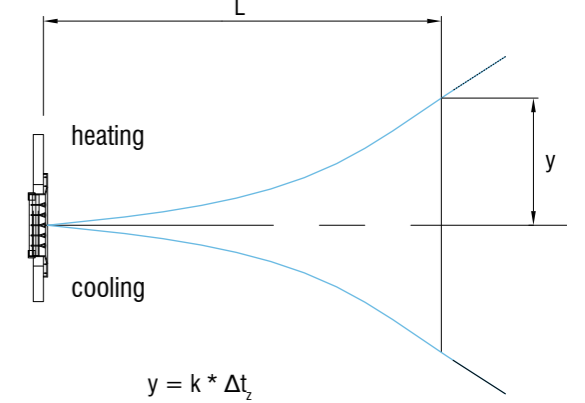

2.7 Discharge with Coanda effect

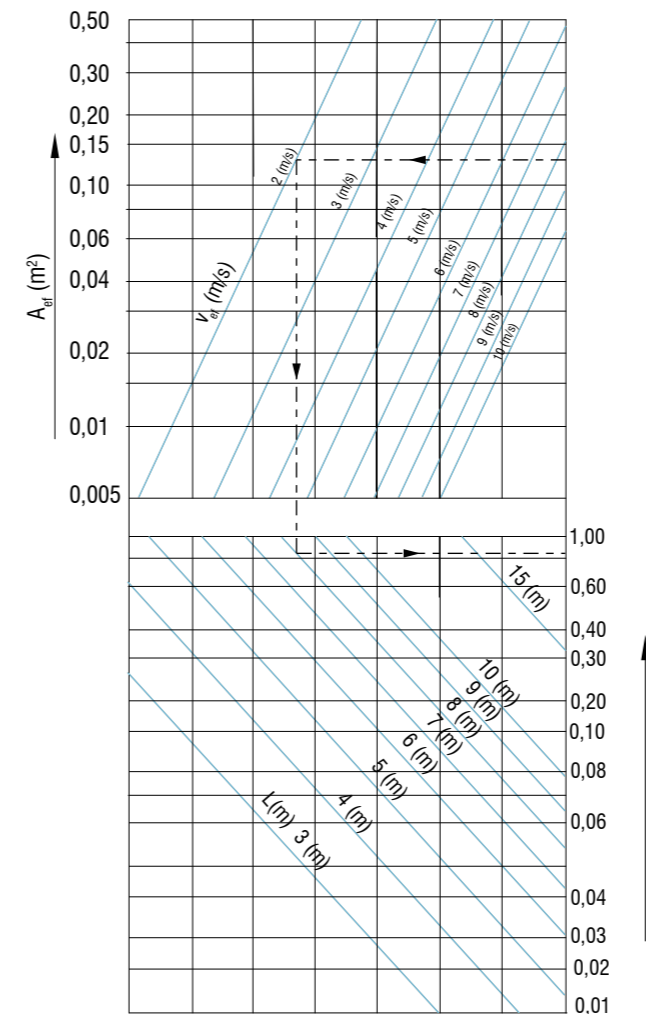

2.8 Discharge without Coanda effect

